

robot coupe®



目錄



瀏覽我們的網站並下載我們的：

• 手冊 • 目錄 • 影片



robot coupe

公司 | 联系我们 | 限制区域 | 中文 - 中国 | English - Hong Kong | More...

宣傳單 視頻 支持

了解我们的产品系列

- 食品切割攪拌及蔬果處理機
- 處理刀齒系列
- 蔬果處理機
- 台式食品切割攪拌機
- 落地式切割攪拌機
- Dixer®：乳化攪拌機

改善飲食結構的最好方法是什麼？

您的最佳烹飪伴侶！

療養院和醫院的最佳解決方案！

請觀看Robot-Coupe®互動目錄



www.robot-coupe.com

第
4頁



食物調理機：切割機及蔬菜
切片機

第
12頁



刀盤組

第
16頁



蔬菜處理機

第
22頁



桌上型切割攪拌機

第
31頁



落地型切割攪拌機

第
33頁



Blixer®：乳化攪拌機

第
40頁



手持式攪拌機

第
45頁



榨汁機

概述

食物調理機：二合一機型！

標配



切割功能



蔬菜處理功能

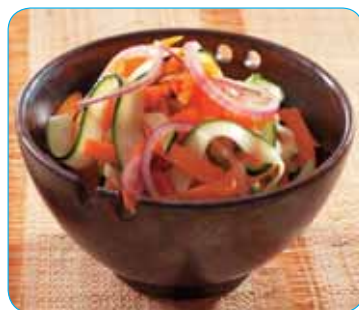



切割功能



平滑刀片



切粗粒



切細粒



醬料, 乳化



粗鋸齒刀片 (選配)

特殊研磨 - 點心



揉捏



研磨



細鋸齒刀片 (選配)

特殊香草及辛香料



香料碎片

蔬菜處理功能

切片



切條



波浪切紋



切丁*



刨絲

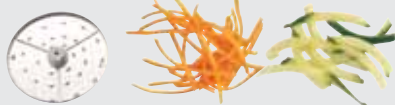

薯條*



*適用 R 402 - R 502 - R 652



切片，波浪切紋，刨絲，切條



選項
23
刀盤

選項
3
刀片

3.7 L

R 301 Ultra

單相

單速

榨汁組



選項
23
刀盤

選項
3
刀片

3.7 L

R 301

單相

單速

榨汁組

+ 切丁及薯條



選項
28
刀盤

選項
3
刀片

4.5 L

R 402 V.V.

單相

多段變速

榨汁組



選項
28
刀盤

選項
3
刀片

4.5 L

R 402

單相

2段變速

榨汁組



切片，波浪切紋，刨絲，切條

+ 切丁及薯條



50
刀片

3
刀片

5.5 L

R 502 V.V.

單相

多段變速

R-Mix®



50
刀片

3
刀片

7 L

R 652 V.V.

單相

多段變速

R-Mix®



50
刀片

3
刀片

7 L

R 652

三相

2段變速



榨汁組

可選配件

R-Mix®

反轉功能

二合一機型!

高性能：兼具切、磨、揉、拌功能的食物調理機。不到 2 分鐘，就能做出一碗鷹嘴豆泥、肉末或茄子泥。

具備完美的研磨、切片及刨絲功能。

耐用：工業用強力感應馬達，可密集使用。



R 301

功率	650 W
電壓	單相
轉速	1500 rpm
切割桶	聚碳酸酯
尺寸 (長x寬x高)	325x300x550 mm
總重	16.1 Kg

選項 23 刀盤

選項 3 刀片

3.7 L



R 301 Ultra

功率	650 W
電壓	單相
轉速	1500 rpm
切割桶	不鏽鋼
尺寸 (長x寬x高)	325x300x550 mm
總重	17 Kg

選項 23 刀盤

選項 3 刀片

3.7 L



建議的刀盤組



2 mm 切片

4 mm 切片

2 mm 刨絲

2x2 mm 切條

切片

刨絲

切條

亞洲型包裝 4 件刀盤組

R 402

選項
28
刀盤

選項
3
刀片

4.5 L

可切3種丁
與2種薯條

功率 750 W
電壓 單相
2段變速 500/1500 rpm
尺寸 (長x寬x高) 320x304x590 mm
總重 20.5 Kg

+ 金屬馬達外殼，不鏽鋼蔬菜處理桶



R 402 V.V.

選項
28
刀盤

選項
3
刀片

4.5 L

可切3種丁
與2種薯條

功率 1000 W
電壓 單相
多段變速 切割功能從 300 至 3500 rpm
蔬菜處理功能從 300 至 1000 rpm
尺寸 (長x寬x高) 320x304x590 mm
總重 20.5 Kg



建議的刀盤組

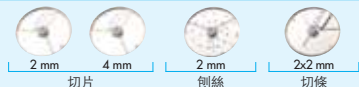

亞洲型包裝 4 件刀盤組



亞洲型包裝 6 件刀盤組，僅 R402 適用



R 502 V.V.

選項
+50
刀盤

選項
3
刀片

5.5 L

可切10種丁
與4種薯條

功率 1300 W
 電壓 單相
 多段變速 切割功能從 300 至 3500 rpm
 蔬菜處理功能從 300 至 1000 rpm
 R-Mix 反轉功能速度從 60 至 500 rpm，
 可輕巧的混合所有食材
 尺寸 (長x寬x高) 378x347x660 mm
 總重 32 Kg

+ 全部金屬馬達外殼及蔬菜處理配件。



建議的刀盤組

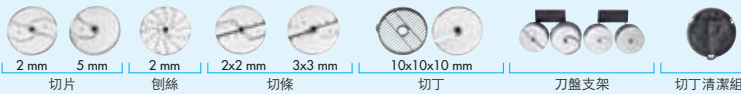

亞洲型包裝 7 件刀盤組



+ 刀盤支架 + 切丁清潔組

多功能切割包裝16件刀盤組



R 652

+50
顆項
刀盤

3
顆項
刀片

5.5 L

可切10種丁
與4種薯條

功率 1200 W
電壓 三相
2段變速 750 / 1500 rpm
尺寸(長x寬x高) 378x347x699 mm
總重 33.4 Kg



R 652 V.V.

+50
顆項
刀盤

3
顆項
刀片

5.5 L

可切10種丁
與4種薯條

功率 1500 W
電壓 單相
多段變速 切割功能從 300 至 3500 rpm
蔬菜處理功能從 300 至 1000 rpm
R-Mix 反轉功能速度從 60 至 500 rpm,
可輕巧的混合所有食材
尺寸(長x寬x高) 378x347x699 mm
總重 33.4 Kg



建議的刀盤組

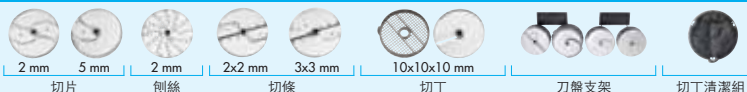

亞洲型包裝 7 件刀盤組



+ 刀盤支架 + 切丁清潔組

多功能切割包裝 16 件刀盤組





應用範圍最廣泛的切片機

切片



■ R 502, R 652, CL 50, CL 50 Gourmet, CL 52, CL 55

■ R 301 Ultra, R 402

 <p>0.6 mm 28166</p> 	 <p>0.8 mm 28069</p> 	 <p>1 mm 28062 27051</p> 	
 <p>2 mm 28063 27555</p> 	 <p>3 mm 28064 27086</p> 	 <p>4 mm 28004 27566</p> 	
 <p>5 mm 28065 27087</p> 	 <p>6 mm 28196 27786</p> 	 <p>8 mm 28066</p> 	 <p>10 mm 28067</p> 
 <p>14 mm* 28068</p> 	 <p>煮熟的馬鈴薯4mm 27244</p> 	 <p>煮熟的馬鈴薯6mm 27245</p> 	

* CL 50 Gourmet 除外



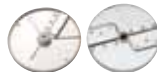









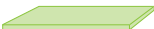











應用範圍最廣泛的切片機



切條

■ R 502, R 652, CL 50, CL 50 Gourmet, CL 52, CL 55

■ R 301 Ultra, R 402









 <p>1x8 mm 28172</p> 	 <p>1x30 mm 28153</p> 	 <p>2x4 mm 27072 27080</p> 	 <p>2x6 mm 27066 27081</p> 
 <p>2x8 mm 27067</p> 	 <p>2x10 mm 28173</p> 	 <p>2x2 mm 28051 27599</p> 	 <p>2.5x2.5 mm 28195</p> 
 <p>3x3 mm 28101</p> 	 <p>4x4 mm 28052 27047</p> 	 <p>6x6 mm 28053 27610</p> 	 <p>8x8 mm 28054 27048</p> 

切薯條



■ R 502, R 652, CL 50, CL 50 Gourmet, CL 52, CL 55

■ R 402

 <p>8x8 mm 28134 27116</p> 	 <p>8x16 mm 28159</p> 	 <p>10x10 mm 28135 27117</p> 	 <p>10x16 mm 28158</p> 
---	--	---	--

應用範圍最廣泛的切片機

刨絲



■ R 502, R 652, CL 50, CL 50 Gourmet, CL 52, CL 55

■ R 301 Ultra, R 402.

 1.5 mm ■ 28056 ■ 27588 	 2 mm ■ 28057 ■ 27577 	 3 mm ■ 28058 ■ 27511 	 4 mm ■ 28073 
 5 mm ■ 28059 	 6 mm ■ 27046 	 7 mm ■ 28016 	 9 mm ■ 28060 ■ 27632 
 帕馬森起司 ■ 28061 ■ 27764 	 瑞士薯餅 ■ 27164 ■ 27191 	 生馬鈴薯 ■ 27219 	 芥末 1 mm ■ 28055 ■ 27078 0.7 mm ■ 27079 1 mm ■ 27130 1.3 mm 

波浪切紋



■ R 502, R 652, CL 50, CL 50 Gourmet, CL 52, CL 55

■ R 301 Ultra, R 402

 2 mm ■ 27068 ■ 27621 	 3 mm ■ 27069 	 5 mm ■ 27070 
---	--	---



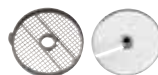









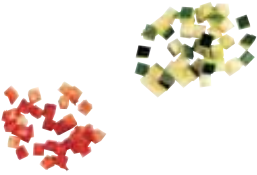

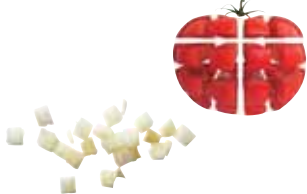

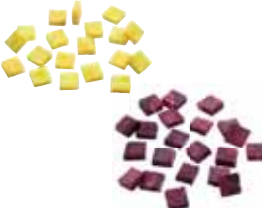
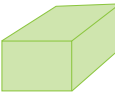

應用範圍最廣泛的切片機

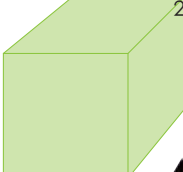

切丁

■ R 502, R 652, CL 50, CL 50 Gourmet, CL 52, CL 55

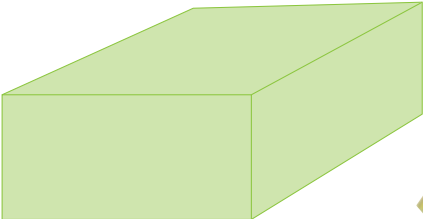
■ R 402

 <p>5x5x5 mm 28110</p> 	 <p>8x8x8 mm 28111 27113</p> 	 <p>10x10x10 mm 28112 27114</p> 
 <p>12x12x12 mm 28197 27298</p> 	 <p>14x14x5 mm 28181</p> 	 <p>14x14x10 mm* 28179</p> 
 <p>14x14x14 mm* 28113</p> 	 <p>20x20x20 mm* 28114</p> 	 <p>25x25x25 mm* 28115</p> 
		<p>50x70x25 mm* 28180</p> 

* CL 50 Gourmet 除外



每小時實際
產出量

每小時理論
產出量



150 kg

500 kg



250 kg

750 kg

切片，波浪切紋，刨絲，切條

+ 切丁及薯條

+ 蔬菜細丁與鬆餅



選項
55
刀盤

CL 50 Gourmet

單相

單速



選項
+50
刀盤

CL 50 Ultra

單相

單速



選項
+50
刀盤

CL 50

單相

單速



選項
+50
刀盤

CL 52

單相

單速

桌上型機型



400 kg

1200 kg



600 kg

1800 kg

切片，波浪切紋，刨絲，切條

+ 切丁及薯條



新型

含多重切碎功能包裝
16件刀盤組

CL 60 Workstation
三個進料頭

三相

2段變速



選項
+50
刀盤

CL 55 2 個進料頭

單相或三相

2段變速



選項
+50
刀盤

CL 60 2 個進料頭

三相

2段變速

落地型型號

高性能：大進料頭可供大量蔬菜處理使用，圓進料頭專門設計供長而易碎的產品使用。全方位的刀盤組讓您輕鬆處理所有處理所有蔬菜水果，不論是切片狀、波浪切紋、研磨、切丁、切條或是火柴棒狀，甚至是炸薯條都能如您所願。

耐用：工業用強力感應馬達，可密集使用。



CL 50

功率	550 W
電壓	單相
轉速	375 rpm
馬達底座	聚碳酸酯
尺寸 (長x寬x高)	390x310x610 mm
總重	19.8 Kg

選項
+50
刀盤

可切10種丁與
4種薯條



於下列網站觀看影片：
www.robot-coupe.com

+ 蔬菜處理金屬配件



CL 50 Ultra

功率	550 W
電壓	單相
轉速	375 rpm
馬達底座	不銹鋼
尺寸 (長x寬x高)	390x310x610 mm
總重	20.2 Kg

選項
+50
刀盤

可切10種丁與
4種薯條



於下列網站觀看影片：
www.robot-coupe.com



CL 52

+50 選項
刀盤
可切10種丁與
4種薯條

功率 750 W
電壓 單相
轉速 375 rpm
尺寸 (長x寬x高) 360x340x690 mm
總重 28 Kg



+ 專門設計用於快速處理大量蔬菜。



建議的刀盤組

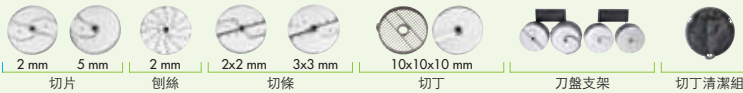

亞洲型包裝 7 件刀盤組



+ 刀盤支架 + 切丁清潔組

多功能切割包裝16件刀盤組

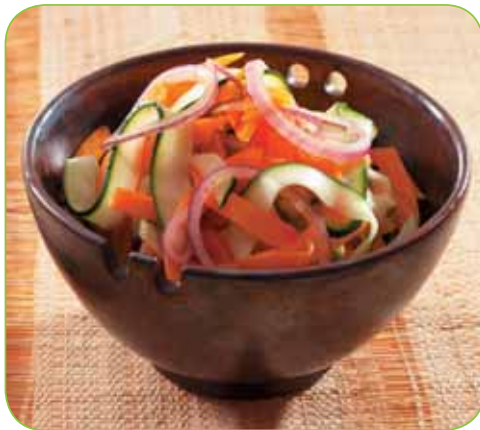



CL 55 2 個進料頭

選項
+50
刀盤

可切10種丁
與4種薯條

功率	1100 W
電壓	單相 三相
速度	375 rpm 750 rpm
自動進料頭	不銹鋼
負荷容量	4.2 公升
尺寸 (長x寬x高)	不包括置機台: 865x396x1272 mm
總重	50 kg



CL 60 2 個進料頭

選項
+50
刀盤

可切10種丁
與4種薯條

功率	1500 W
電壓	三相
2段變速	375 & 750 rpm
自動進料頭	不銹鋼
手動進料頭	238 cm ² - 容量 4.2 公升
尺寸 (長x寬x高)	600x720x1225 mm
總重	85 Kg



建議的刀盤組



亞洲型包裝 7 件刀盤組



+ 刀盤支架 + 切丁清潔組

多功能切割包裝16件刀盤組

CL 60 WORKSTATION 全方位蔬菜處理方案

新型



每小時達
1800 kg
蔬菜量

可調式腳架
可穩定於各種地板

工作檯置物推車

- 一合推車容納所有配件!
- 置物盤可放置 16 個刀盤及 8 個配件
- 1 個 GN 容器收納檯車
- 3 個斜槽:
 - 推式進料頭
 - 4 管進料頭
 - 自動進料頭

+ 多功能切割包裝16件刀盤組

自動進料頭

適合所有散裝蔬菜
(蕃茄、洋蔥、
馬鈴薯...)

推式進料頭

專用於體積大的蔬
菜 (例如高麗菜、
塊根芹菜)

4 管進料頭

專用於長形蔬菜，
如小黃瓜或櫛瓜。

馬鈴薯壓榨機 3 mm

適合壓碎量
大的熟馬鈴
薯。

人體工學行動推車

附三個全尺寸平底鍋



聚碳酸酯材質的外蓋，讓您在處理加工食材時可添加液體或配料。



100% 不銹鋼、平滑刀緣、可拆式刀片 (R6以上型號)。

另有粗鋸齒刀片及細鋸齒刀片可供選擇。





平滑刀片



切粗粒



粗鋸齒刀片

特殊研磨 - 巴西利



揉捏



細鋸齒刀片

特殊香草及辛香料



香料碎片



切細粒



研磨



醬料，乳化



每批數量



1 kg



1.5 kg



2.5 kg

多段變速 300 到 3500 rpm

選購
3
刀片

4.5 L



R 4 V.V.

單相

轉速 3000 rpm

選購
3
刀片

3.7 L



R 3-3000

單相

轉速 1500 rpm

選購
3
刀片

2.9 L



R 2

單相

選購
3
刀片

3.7 L



R 3-1500

單相

選購
3
刀片

4.5 L



R 4-1500

單相



3 kg



3.5 kg



5 kg

多段變速 300 到 3500 rpm



R 5 V.V.

單相

R-Mix®



R 6 V.V.

單相

R-Mix®



R 8 V.V.

單相

R-Mix®

2段變速 1500/3000 rpm



R 5 Plus

三相



R 6

三相



R 8

三相



R-Mix®

反轉功能



R 2

選項
3
刀片

2.9 L

功率	550 W
電壓	單相
轉速	1500 rpm
不銹鋼桶	2.9 公升
功能	寸動
尺寸 (長×寬×高)	200x280x350 mm
總重	10.5 Kg



R 3-1500

選項
3
刀片

3.7 L

功率	650 W
電壓	單相
轉速	1500 rpm
不銹鋼桶	3.7 公升
功能	寸動
尺寸 (長×寬×高)	210x320x400 mm
總重	11.2 Kg



R 3-3000

選項
3
刀片

3.7 L

功率	650 W
電壓	單相
轉速	3000 rpm
不銹鋼桶	3.7 公升
功能	寸動
尺寸 (長×寬×高)	210x320x400 mm
總重	13.1 Kg

高性能：兼具切、磨、揉、拌功能的檯式切割攪拌機。不到 2 分鐘，就能做出一碗肉末或杏仁醬。所有型號都配備寸動功能，以便更精準的控制。

所有型號都配有寸動按鈕，可進行更精確的控制。

耐用：工業用強力感應馬達，可密集使用。

R 4-1500

選項
3
刀片

4.5 L

功率	700 W
電壓	單相
轉速	1500 rpm
尺寸 (長x寬x高)	226x304x460 mm
總重	17 Kg



R 4 V.V

選項
3
刀片

4.5 L

功率	1000 W
電壓	單相
多段變速	300 到 3500 rpm
尺寸 (長x寬x高)	226x304x460 mm
總重	17 Kg





R 5 Plus

選項
3
刀片 5.5 L

功率	1200 W
電壓	三相
2 段變速	1500/3000 rpm
尺寸 (長x寬x高)	280x350x490 mm
總重	24.5 Kg

+ 把手設計，可輕鬆倒出鋼桶內食材



R 5 V.V.

選項
3
刀片 5.5 L

功率	1300 W
電壓	單相
多段變速	300 到 3500 rpm
R-Mix 功能	反轉轉速 60 至 500 rpm，可輕巧的混合所有食材
尺寸 (長x寬x高)	280x350x490 mm
總重	24.5 Kg



R 6

選項
3
刀片

7L

功率	1300 W
電壓	三相
2 段變速	1500/3000 rpm
尺寸 (長x寬x高)	280x350x520 mm
總重	24.8 Kg



R 6 V.V.

選項
3
刀片

7L

功率	1500 W
電壓	單相
多段變速	300 到 3500 rpm
R-Mix 功能	反轉速度 60 至 500 rpm，可輕巧的混合所有食材
尺寸 (長x寬x高)	280x350x520 mm
總重	25.7 Kg





R 8

功率 2200 W
 電壓 三相
 2 段變速 1500/3000 rpm
 尺寸 (長x寬x高) 315x545x585 mm
 總重 44.9 Kg

3 刀片 8 L



+ 所有不銹鋼平滑刀片組為標準配備。



在

最短時間

內

得到

最大

效果

高性能



精準



方便



符合人體工學



高性能：Robot-Coupe 落地型切割攪拌機具備雙重特色，能處理大量及小量的肉品、蔬菜、醬料、塔皮、巧克力甘納許...。

耐用：工業用強力感應馬達，可密集使用，整台不銹鋼製成。



R 30

功率 5400 W
 電壓 三相
 2 段變速 1500/3000 rpm
 尺寸 (長x寬x高) 720x600x1250 mm
 總重 148.4 Kg

3
刀片

28 L



R 60

功率 11000 W
 電壓 三相
 2 段變速 1500/3000 rpm
 尺寸 (長x寬x高) 810x600x1400 mm
 總重 201.2 Kg

3
刀片

28 L



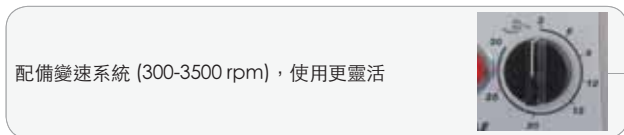
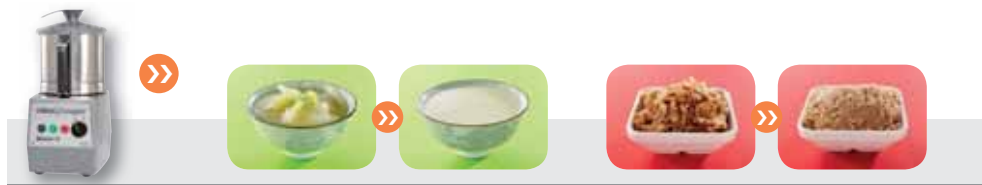

200 g 份數:



0.3 到 2 kg



0.4 到 3 kg



0.5 到 3.5 kg

每次操作的
處理量

多段變速 300 到 3500 rpm



4.5 L

Blixer 4 V.V.

單相



5.5 L

Blixer 5 V.V.

單相

轉速 3000 rpm



3.7 L

Blixer 3

單相



4.5 L

Blixer 4

單相

2 段變速 1500/3000 rpm



5.5 L

Blixer 5 Plus

三相

處理能力

型號	鋼桶容量 (公升)	處理量 (公斤)		200 g 份數:
		最少	最多	
Blixer 3	3.7	0.3	2	2 到 10
Blixer 4 3000 - 4 V.V.	4.5	0.4	3	2 到 15
Blixer 5 Plus - 5 V.V.	5.5	0.5	3.5	3 到 18
Blixer 6 V.V.	7	0.6	4.5	3 到 23
Blixer 15	15	3	10	15 到 50



0.6 到 4.5 kg



3 到 10 kg

多段變速 300 到 3500 RPM



7 L

Blixer 6 V.V.

單相

2段變速 1500/3000 rpm



15 L

Blixer 15

三相

如何選擇適合的 BLIXER® ?

1. 計算需要進行質地調整的膳食需求量

	平均份量	需要產出的份數	總重量	200 g 份數:
開胃菜	80 g	x <input type="text"/> 份數	= <input type="text"/> g	
肉/魚	100 g	x <input type="text"/> 份數	= <input type="text"/> g	
蔬菜	200 g	x <input type="text"/> 份數	= <input type="text"/> g	
甜點	80 g	x <input type="text"/> 份數	= <input type="text"/> g	

2. 每次操作的處理量顯示於頁面頂端



健康照護 – 製備軟質膳食

Robot-Coupe 推出全方位的 Blixer® 共 17 款，滿足您的各種調理需求。Blixer® 不加水即能處理黏稠固態食物，完全取代廚房攪拌機的功能，適合處理：

- 胡蘿蔔泥/乳化
- 生紫甘藍菜和芹菜
- 生蕃茄和小黃瓜
- 鑲蕃茄
- 鮭魚排飯
- 燉小牛肉佐白醬
- 洋梨杏仁舒芙蕾
- 青蘋果派
- 綜合米布丁
- 香橙塔
- 薑黃
- ...

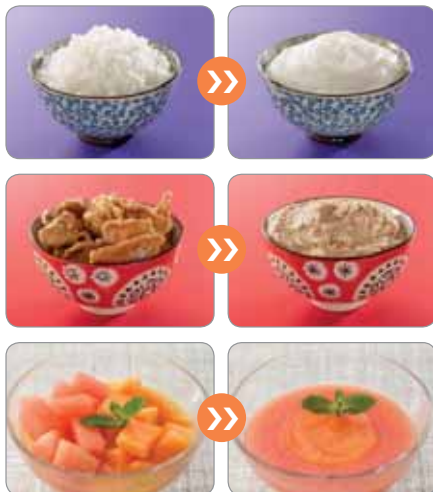

研磨辛香料

Blixer 不僅可應用於混合/切碎食材，還適合處理所有香料

- 芝麻，
- 紅辣椒粉，
- 咖哩，
- 薑，
- 蕃紅花
- 辣椒，
- 馬薩拉，
- 匈牙利紅椒，
- 葛拉姆馬薩拉
- 五香粉，
- 香茅，
- 蝦米，
- 肉桂捲，
- ...



Blixer 3

3.7 L

功率	750 W
電壓	單相
轉速	3000 rpm
不銹鋼桶	3.7 公升
尺寸 (長x寬x高)	242x304x444 mm
總重	13.2 Kg

**Blixer 4-3000**

4.5 L

功率	900 W
電壓	單相
轉速	3000 rpm
不銹鋼桶	4.5 公升
尺寸 (長x寬x高)	242x304x444 mm
總重	14.8 Kg

**Blixer 4 V.V.**

4.5 L

功率	1100 W
電壓	單相
多段變速	300 到 3500 rpm
不銹鋼桶	4.5 公升
尺寸 (長x寬x高)	242x325x479 mm
總重	17.3 Kg



高性能：Blixer® 結合兩大食物處理功能：切割功能與攪拌/混合功能。所有型號都配備一個鋼桶刮刀，可處理黏稠的食材。

耐用：工業用強力感應馬達，可密集使用。

Blixer 5 Plus

5.5 L



功率	1300 W
電壓	三相
2段變速	1500/3000 rpm
尺寸 (長x寬x高)	280x350x500 mm
總重	24 Kg

+ 金屬馬達外殼



Blixer 5 V.V.

5.5 L



功率	1400 W
電壓	單相
多段變速	300 到 3500 rpm
尺寸 (長x寬x高)	280x350x500 mm
總重	25 Kg



Blixer 6 V.V.

7 L

功率	1500 W
電壓	單相
多段變速	300 到 3500 rpm
尺寸 (長x寬x高)	280x350x535 mm
總重	26.3 Kg

**Blixer 15**

15 L

功率	3000 W
電壓	三相
2段變速	1500/3000 rpm
尺寸 (長x寬x高)	315x545x700 mm
總重	58.7 Kg





大型

MP

Easy Plug

440 W

440 W

500 W

750 W



MP 350 Ultra

MP 350 Combi Ultra

MP 450 Ultra

MP 550 Ultra

50 公升

50 公升

100 公升

200 公升

6.1 Kg

8.3 Kg

6.4 Kg

6.7 Kg

專供大餐廳、央廚等及餐飲業者。可密集使用。

中型

CMP

310 W

350 W

350 W

400 W



CMP 250 VV

CMP 300 VV

CMP 300 Combi

CMP 350 V.V.

15 公升

30 公升

30 公升

45 公升

3.7 Kg

3.8 Kg

5.7 Kg

4 Kg

小餐廳適用

迷你

Mini MP

新型

220 W

270 W

290 W



MicroMix



Mini MP 190 V.V.



Mini MP 240 V.V.

9 公升

12 公升

1.4 Kg

適合處理少量食材

▶ 專供乳化之用

▶ 適合處理少量食材

▶ 餐廳適用

▶ 專供機構及餐飲業者。可密集使用。

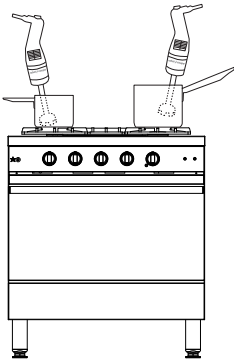

MicroMix® Mini MP

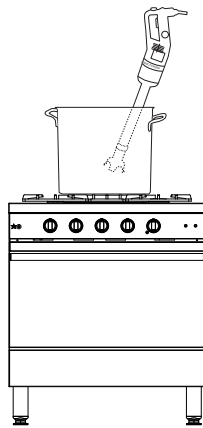

CMP

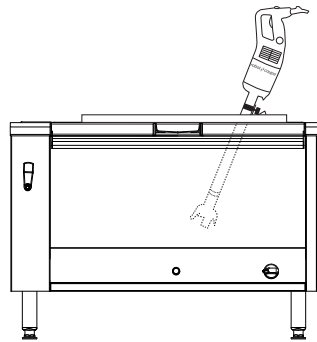

MP Ultra

新型

MicroMix®

大廚首選，瞬間乳化

性能

全新鐘形設計，速度更快。
結合強有力與極靜音於一體的設計

多段變速

1500 到 14000 rpm

堅固耐用

100% 不銹鋼管、鐘形、馬達與拆卸工具

符合人體工學

精準方便的速度設定調節鈕。
可延展纏繞的電源線，使用方便。

衛生

可拆式攪拌桿與刀片，方便清洗。
可收納攪拌機與拆卸工具的支架。



AEROMIX

專利



獲得專利的工具，可即時生產質輕而膨鬆的乳化製品，且能保持其外形。



刀具

可製作小份量的湯品與醬料。

迷你系列



AEROMIX

專供乳化
之用

Mini MP 190 VV, Mini MP 240 VV
最迷你的尺寸、最大的處理性能。
適用醬料與小份量食材



把手輕鬆抓握，使用方便。



可拆式刀片與鐘罩，方便清洗，確保食品衛生無虞。



刀片設計可發揮食材混合的極致效果。

新型



270 W

190 mm

Mini MP 190 VV



290 W

240 mm

Mini MP 240 VV

多段變速



變速按鈕可輕鬆使用與控制。



強力馬達延長電器的使用壽命。



專利

特殊 Aeromix 工具，可即時生產輕而膨鬆的乳化製品，且能保持其外形。

中型系列 CMP

小巧精實，方便操作，滿足餐飲需求。

變速
從 2300 至 9600 rpm，適用混合功能
從 500 至 1800 rpm，適用打蛋器機 型



全新可拆式
100% 不銹鋼
鐘罩

不銹鋼

不銹鋼



功率

馬達功率更強：
功率增加 15%，
更有效率。



方便

變速系統，使
用更靈活 - 適
合處理複雜的
食材



符合人體工學

輕巧的電器用
品，操作方便



衛生

可拆式不銹鋼
刀片及鐘罩，
清洗、維護都
方便。



多用途

CMP Combi
型號 (混合+攪
打) 配備全新
100% 不銹鋼
鐘罩



性能

短時間內就能
製作出完美混
合、質地細緻
的成品。



大型系列 MP ULTRA

符合人體工學



全新改良把手，符合人體工學，使用更方便。



Combi V.V. 機型有變速按鈕，單手就可輕鬆使用。



機身上的卡榫可做為支點，架在鍋緣上大為減重，操作起來更輕鬆。



新型電源線纏繞系統，方便收納、延長使用壽命。

轉速

MP 350 Ultra : 9500 rpm
MP 450 Ultra : 9500 rpm
MP 550 Ultra : 9000 rpm

多段變速

MP 350 Combi Ultra :
從 1500 至 9000 rpm，適用混合功能
從 250 至 1500 rpm，適用攪打功能

可拆式電源線



新專利「易接插頭」系統，可快速更換電源線。

衛生

可拆式不銹鋼刀片及鐘罩，清洗、維護都方便。



不銹鋼

不銹鋼

不銹鋼

不銹鋼

不銹鋼

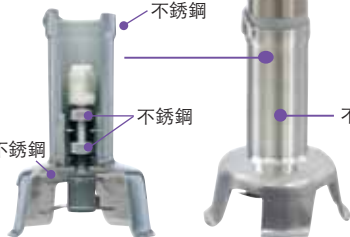

高性能：Centrifugal Juicer 果汁機，能輕鬆快速的處理高品質的新鮮果汁！其製成的果汁格外滑順、風味飽滿。J80/J100 的靜音水準，即使在客人面前也能輕鬆自在準備飲品。

耐用：工業用強力感應馬達，可密集使用。

J 80 Ultra

功率	700 W
電壓	單相
轉速	3000 rpm
尺寸 (長x寬x高)	235x535x502 mm
總重	12.8 Kg

+ 7 秒就能製作一杯頂級新鮮果汁！



J 100 Ultra

功率	850 W
電壓	單相
轉速	3000 rpm
尺寸 (長x寬x高)	235x538x596 mm
總重	15.6 Kg

+ 專門設計可密集使用。果渣排出槽直接將排出的果渣排入工作檯下方的果渣桶內。
冷水壺的高度足以放在果汁流出口下方。



J 100 ULTRA JUICER 果汁機，設計專供密集使用

大進料頭 (Ø 79 mm) 可處理整顆水果或蔬菜，例如蘋果或蕃茄。



冷水壺的高度足以放在果汁流出口下方。



兩種榨汁方式:

❶ 果渣連續排出：

果渣排出槽直接將排出的果渣排入工作檯下方的果渣桶內。



❷ 果渣排入果渣桶：

7.2 公升大容量半透明果渣桶。



❶ 果渣直接排入工作檯下方的果渣桶:





robot coupe®

ROBOT-COUPÉ s.n.c.

法國總公司，出口與行銷部：

電話：+ 33 1 43 98 88 33 - 傳真：+ 33 1 43 74 36 26

48, rue des Vignerons - 94305 Vincennes Cedex -
France

電子信箱：international@robot-coupe.com

www.robot-coupe.com

經銷商